

# PST-184P

Option A  
Pendant

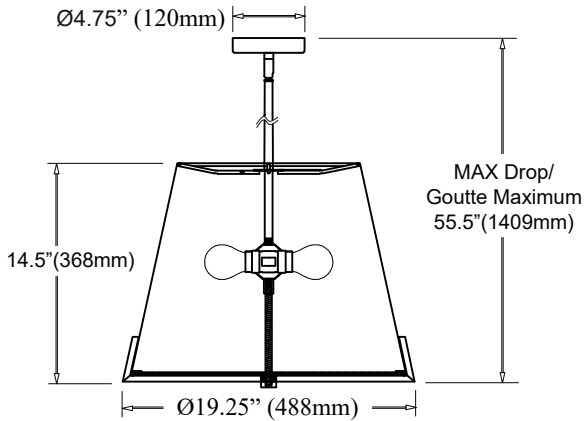

Option B  
Semi-Flush

