

LAILA



DLEDW-310-BK



DLEDW-310-BA



DLEDW-310-BZ



DLEDW-310-WH

Description:

- The "LAILA" series "Full Moon" LED step/wall light is suitable for indoor or outdoor wall mount use. Ideal for retrofit applications. It is much easier to drill 31/8" (79.4mm) hole than cut 2" x 4" rectangle.
- This product is designed to be installed after wall sheeting material has been applied.
- Product supplied with its own plastic UL approved housing.
- Has no visible screws providing clean seamless finish.

Features:

- Die cast aluminum body with powder coated paint finish.
- Polycarbonate white lens.
- Available in Black, White, Bronze or Brushed Aluminum finish.
- Uses 3.3W LED - 2700°K - 85 + CRI - included.
- 120V direct wiring - multiple fixtures can be wired together in parallel.
- The LED module is removable and can be replaced if required using exactly same binning.
- Includes integral 120V LED driver.
- Smooth and continuous dimming (to 10%) can be achieved using Lutron DVELV-300P and MAELV-600 and Legrand ADTH700.
- 40,000 hours rated life.
- 5 year limited warranty.

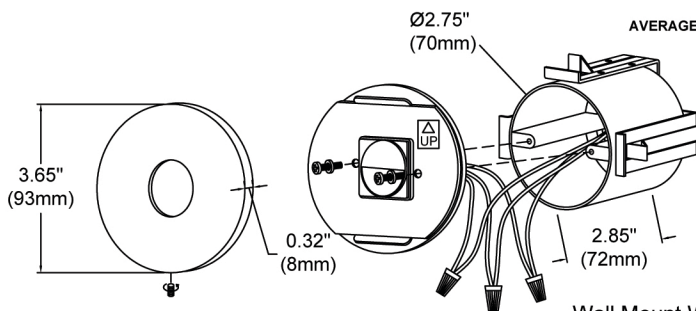
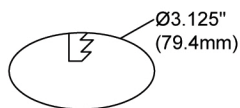
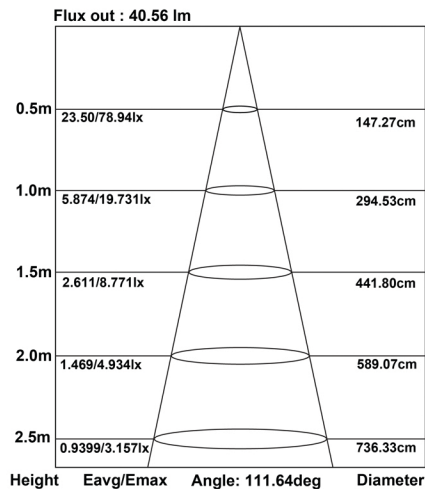
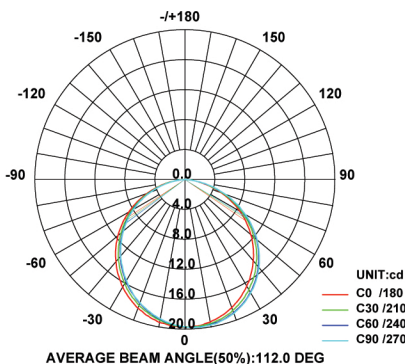

Spacing Recommendations

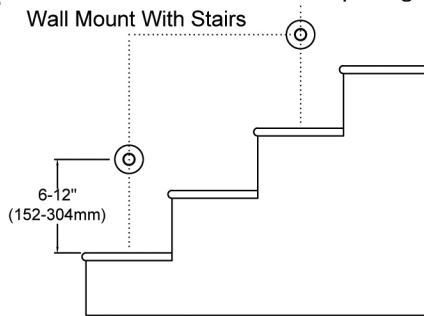

Step Mount For Stairs

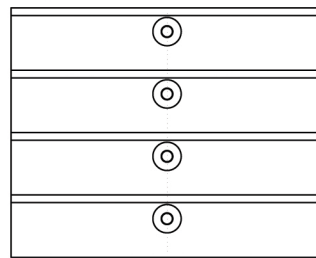

Mount in center of stair as close to the upper tread as possible

Hallways

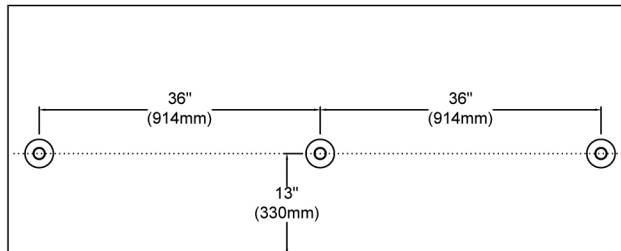

Data:

- Input voltage 120V
- Input power 3.3W
- Input current 0.03A
- Frequency 60Hz
- Min starting temp.-20°C(-4°F)
- CRI 85+
- CCT 2700°K*
- Lumens..... 237Lm



*Please be advised that this series can also be ordered with special lenses to change colour output. Available in Amber, Blue and Red.

